



Turnierpläne

In der Broschüre Turnierformen sind die Beschreibungen der hier abgebildeten Turnierpläne zu finden.

Bezugsquelle:
Bundesamt für Sport BASPO
J+S-Dokumentation
2532 Magglingen
E-Mail: dok.js@baspo.admin.ch

Weitere Informationen

Bei den unten aufgeführten Verbänden erhältst du weitere Informationen.

swiss badminton
www.badminton.ch

SWISS SQUASH
www.squash.ch

Swiss Tennis
www.myTennis.ch

Schweizerischer Tischtennis-Verband
www.sttv.ch





K.O.-Turnier

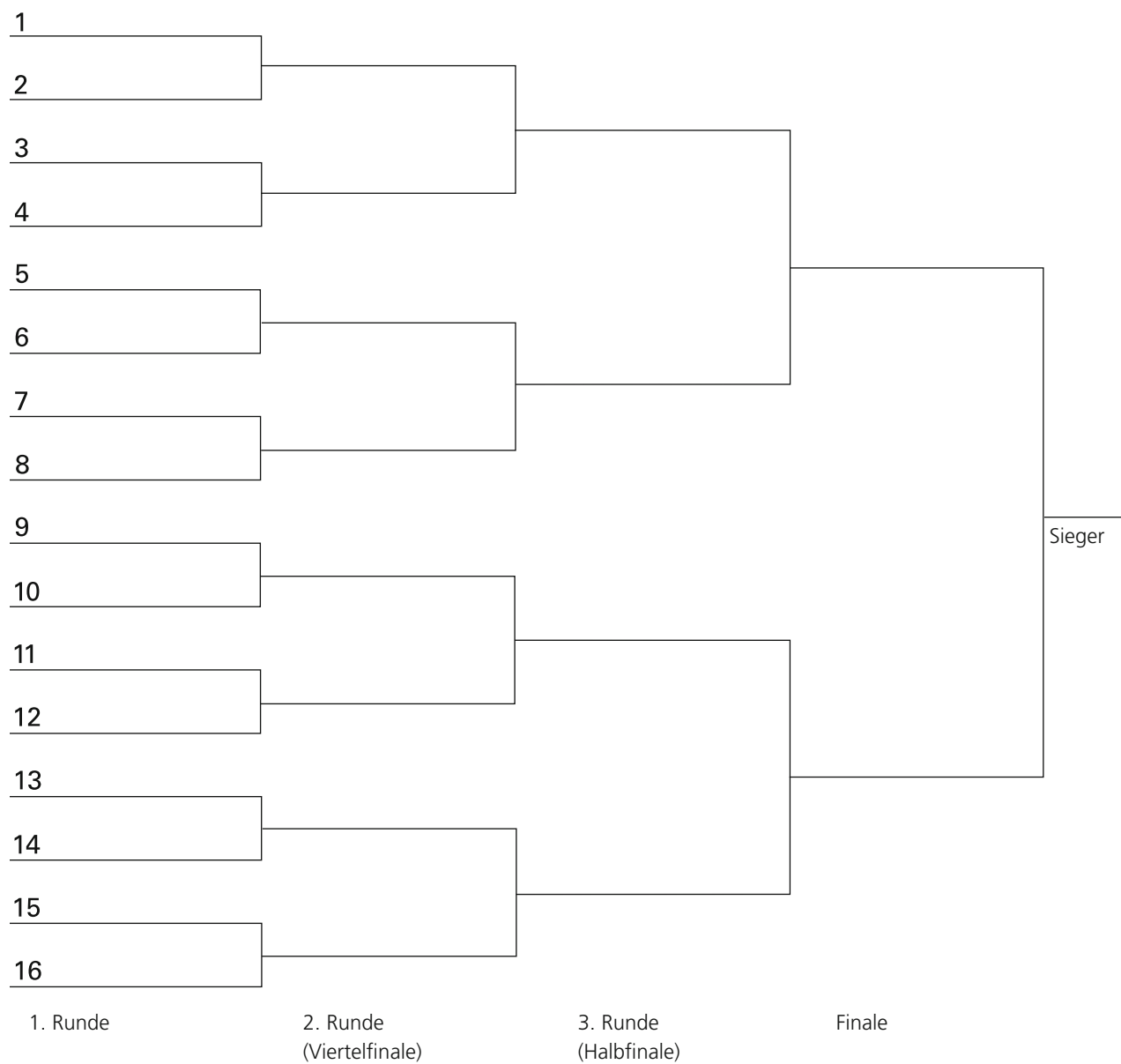



K.O.-Turnier

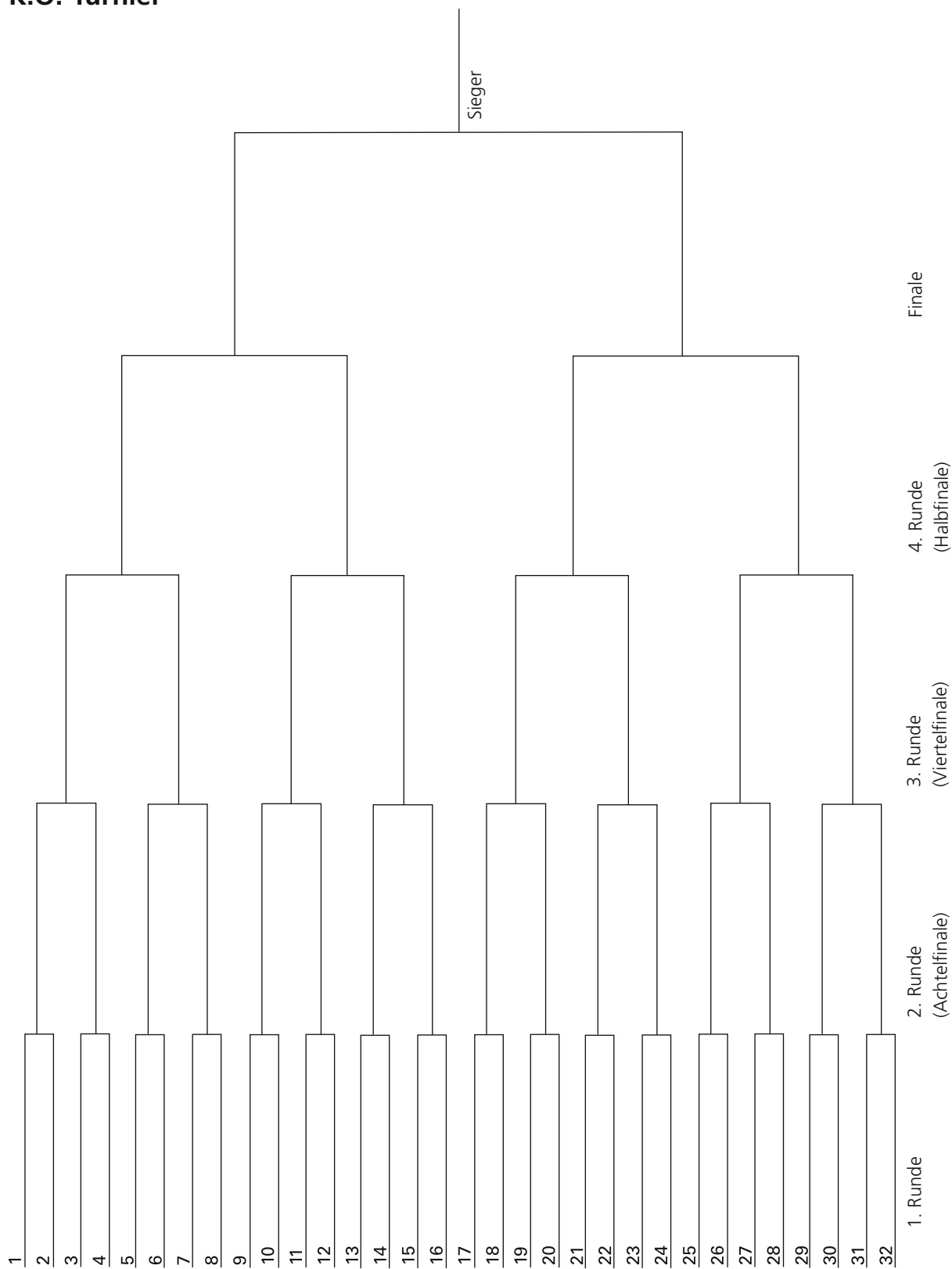



Doppeltes K.O.-Turnier

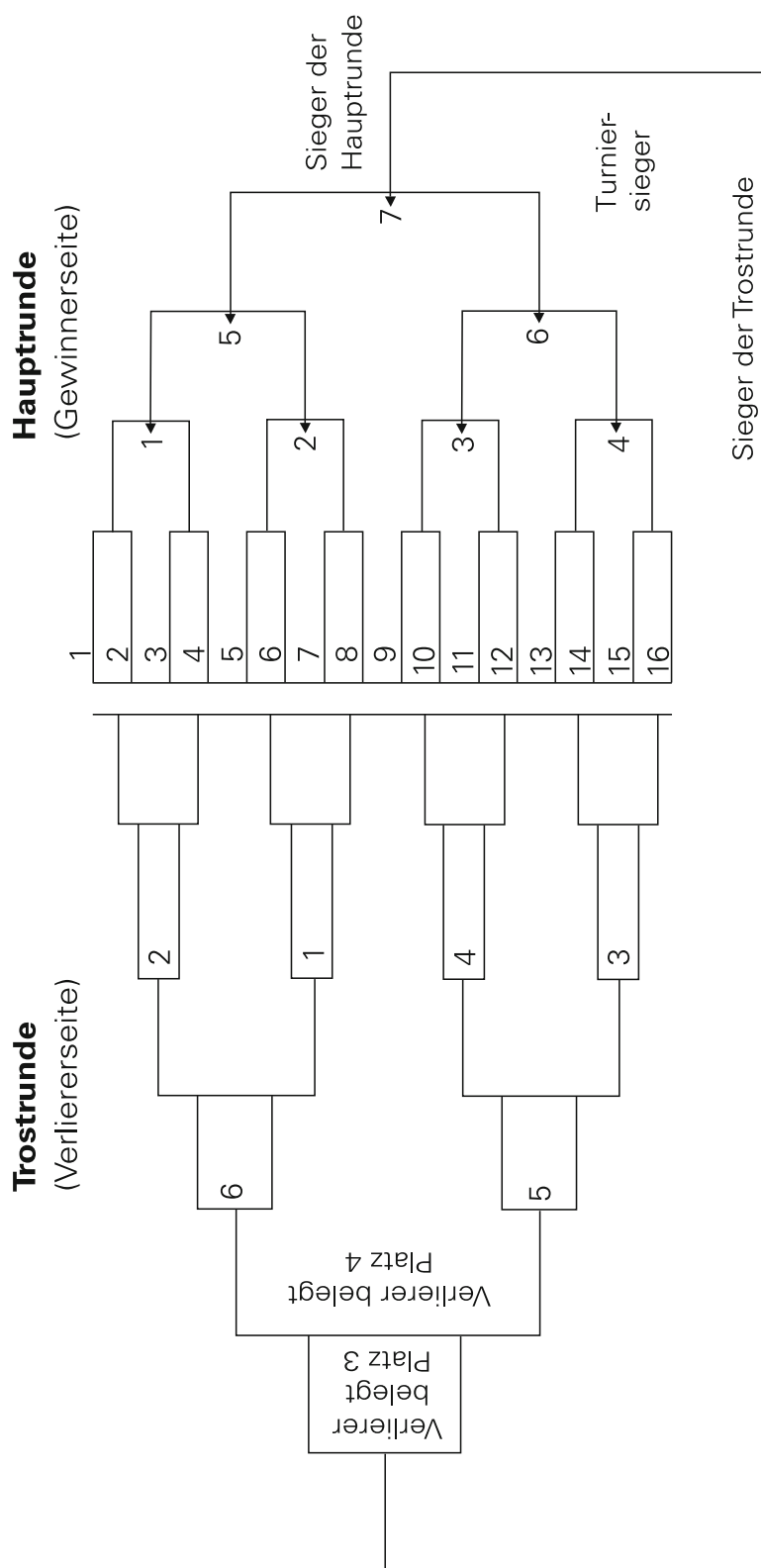



Doppeltes K.O.-Turnier

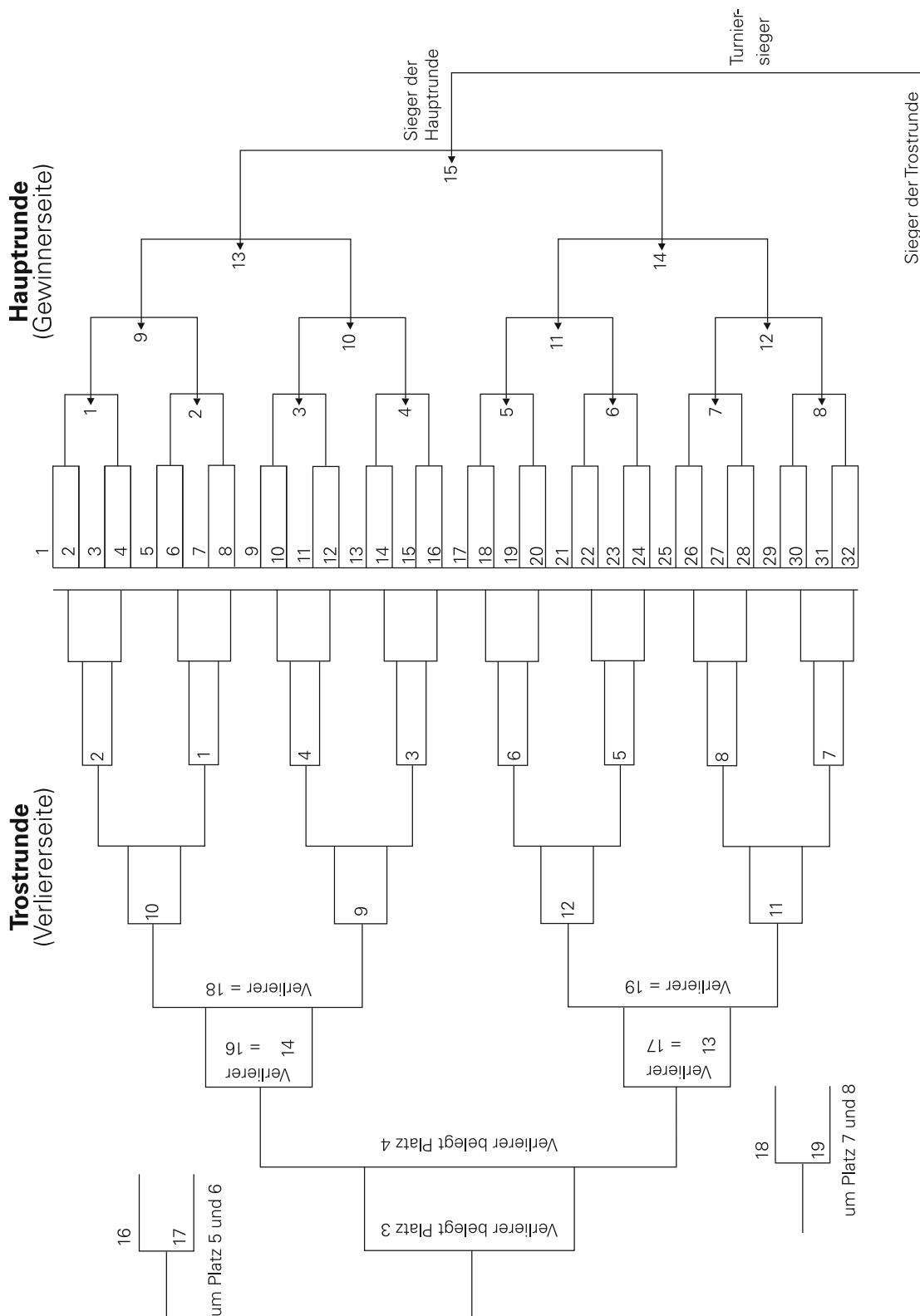



Ranglistenturnier

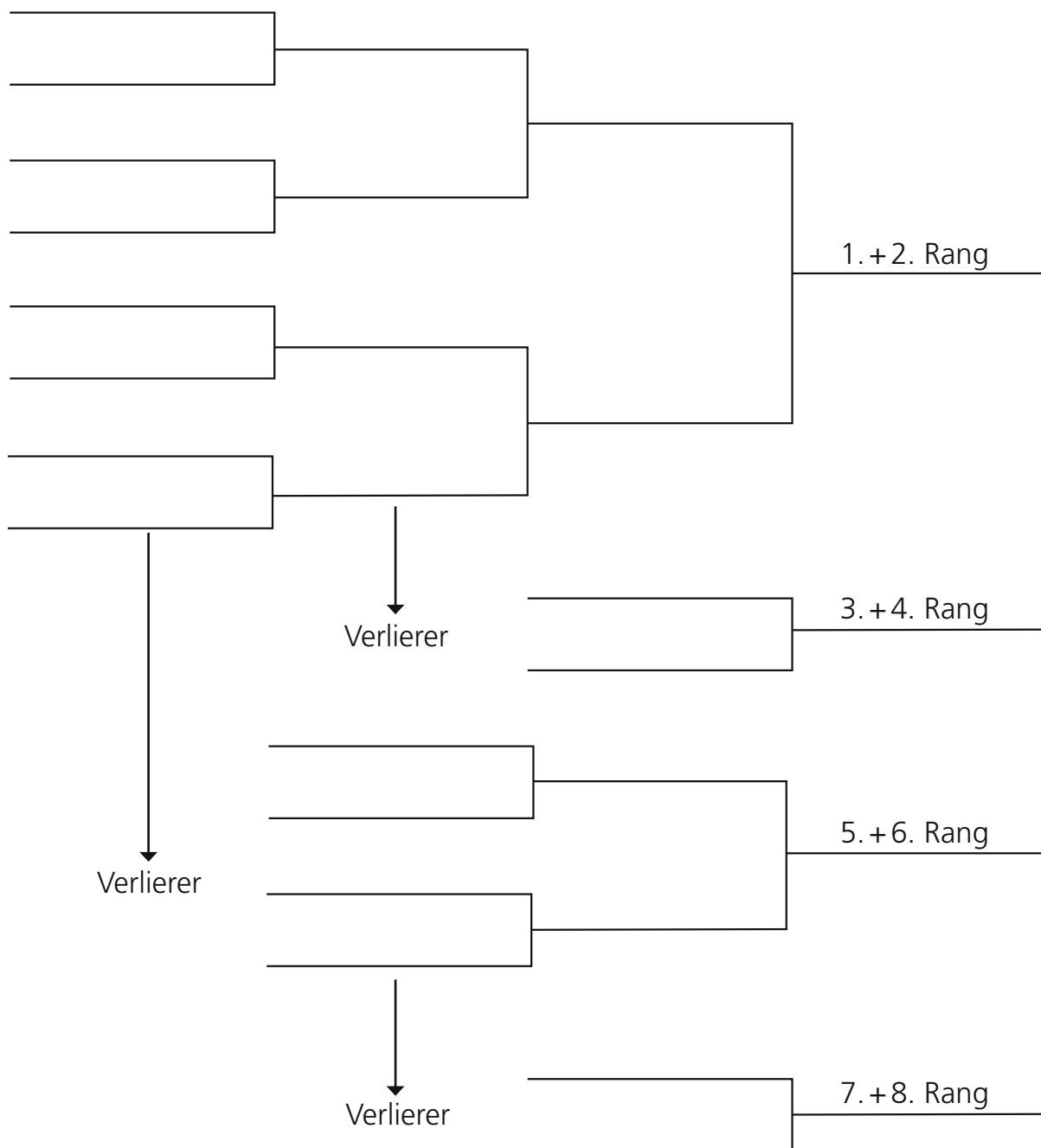



Ranglistenturnier

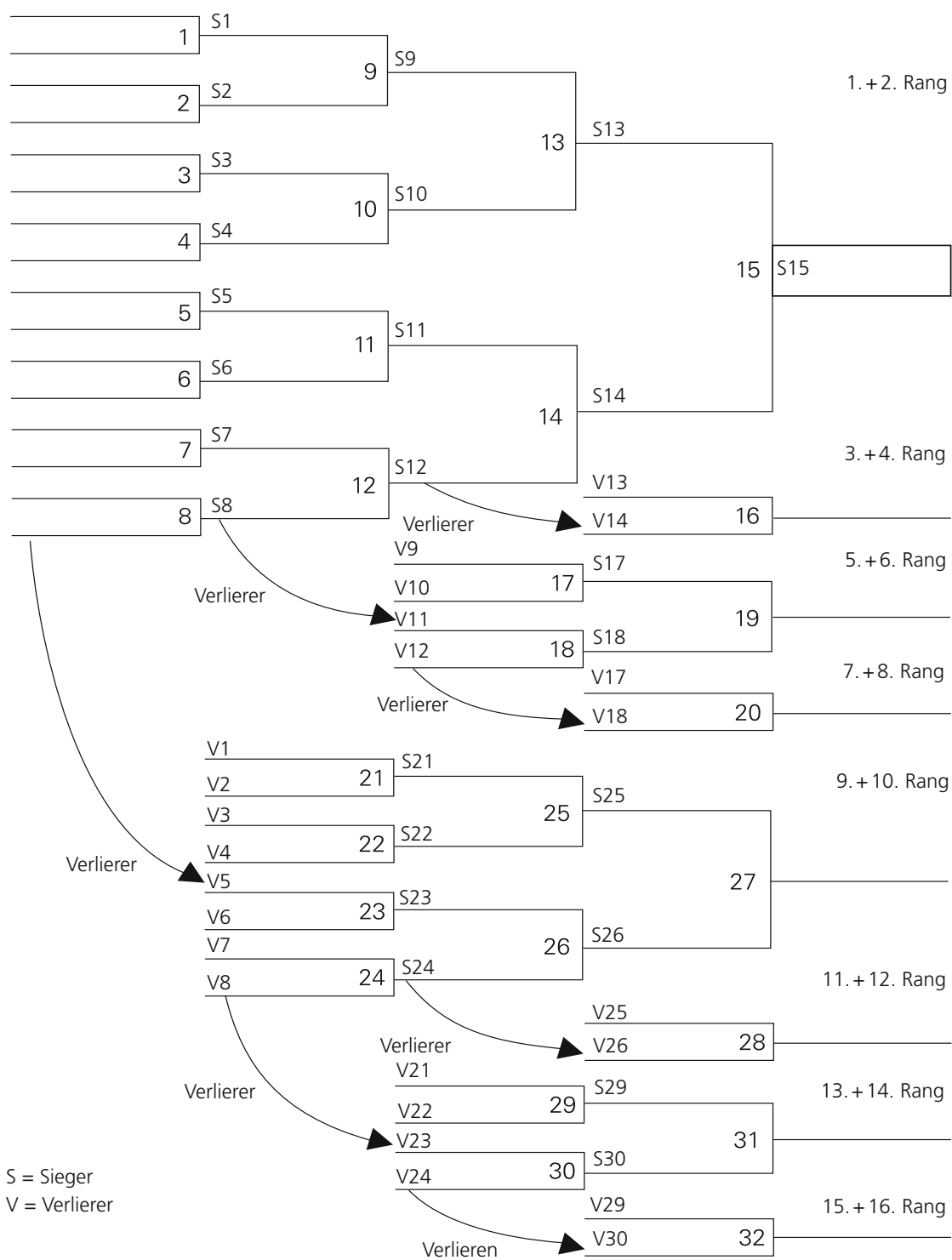



Ranglistenturnier

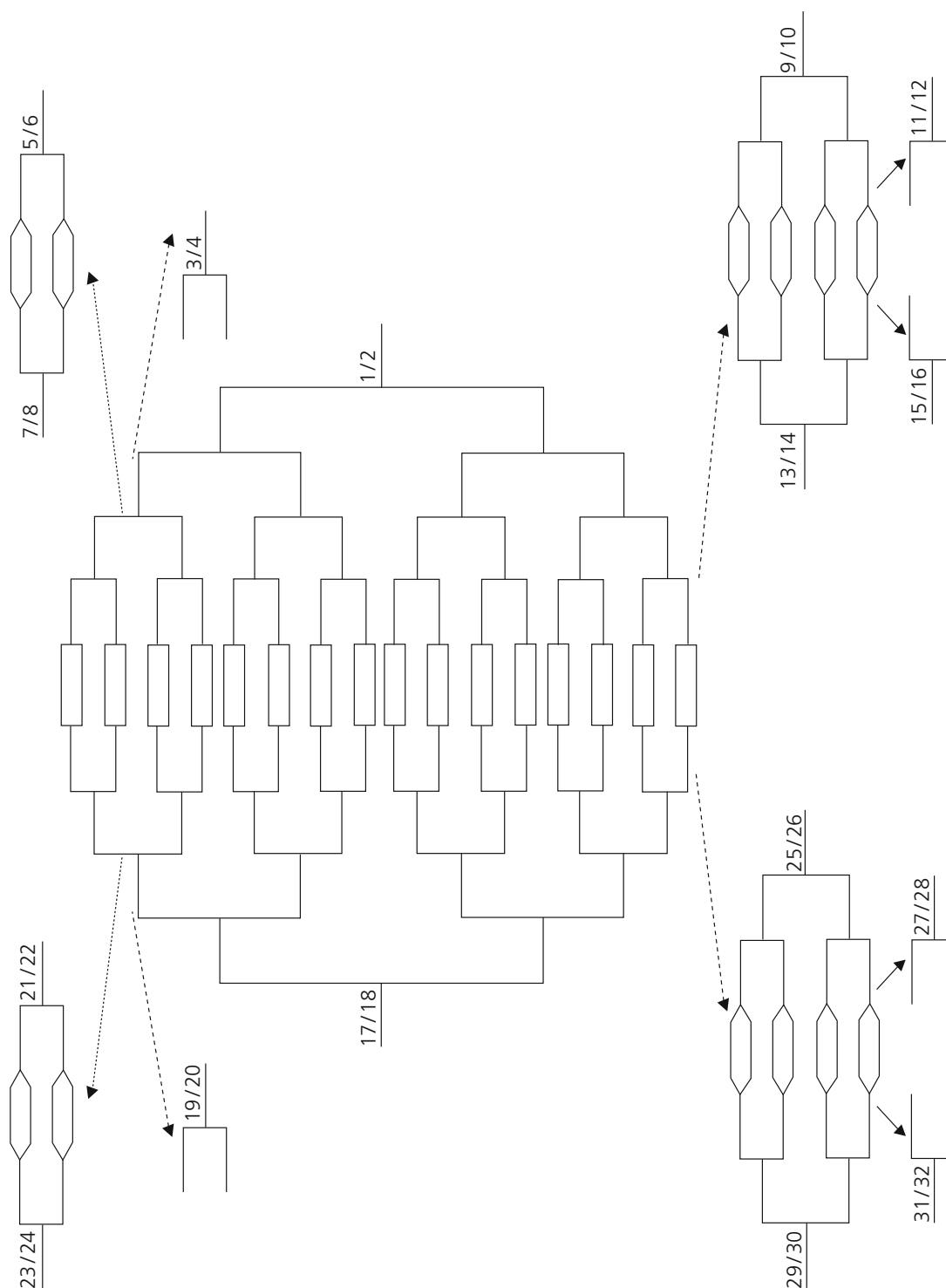



K.O.-Pool-Turnier

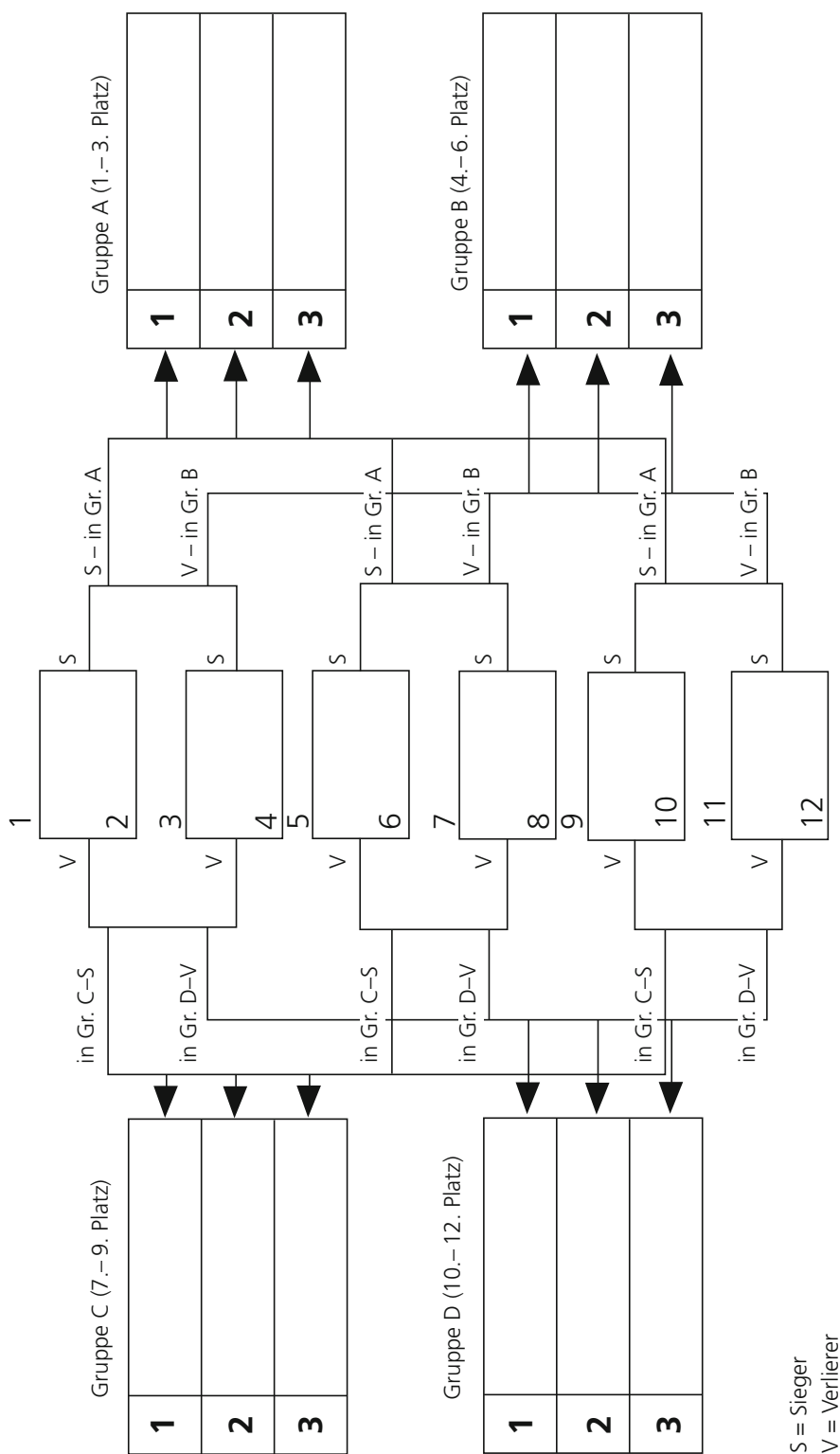



K.O.-Poll-Turnier

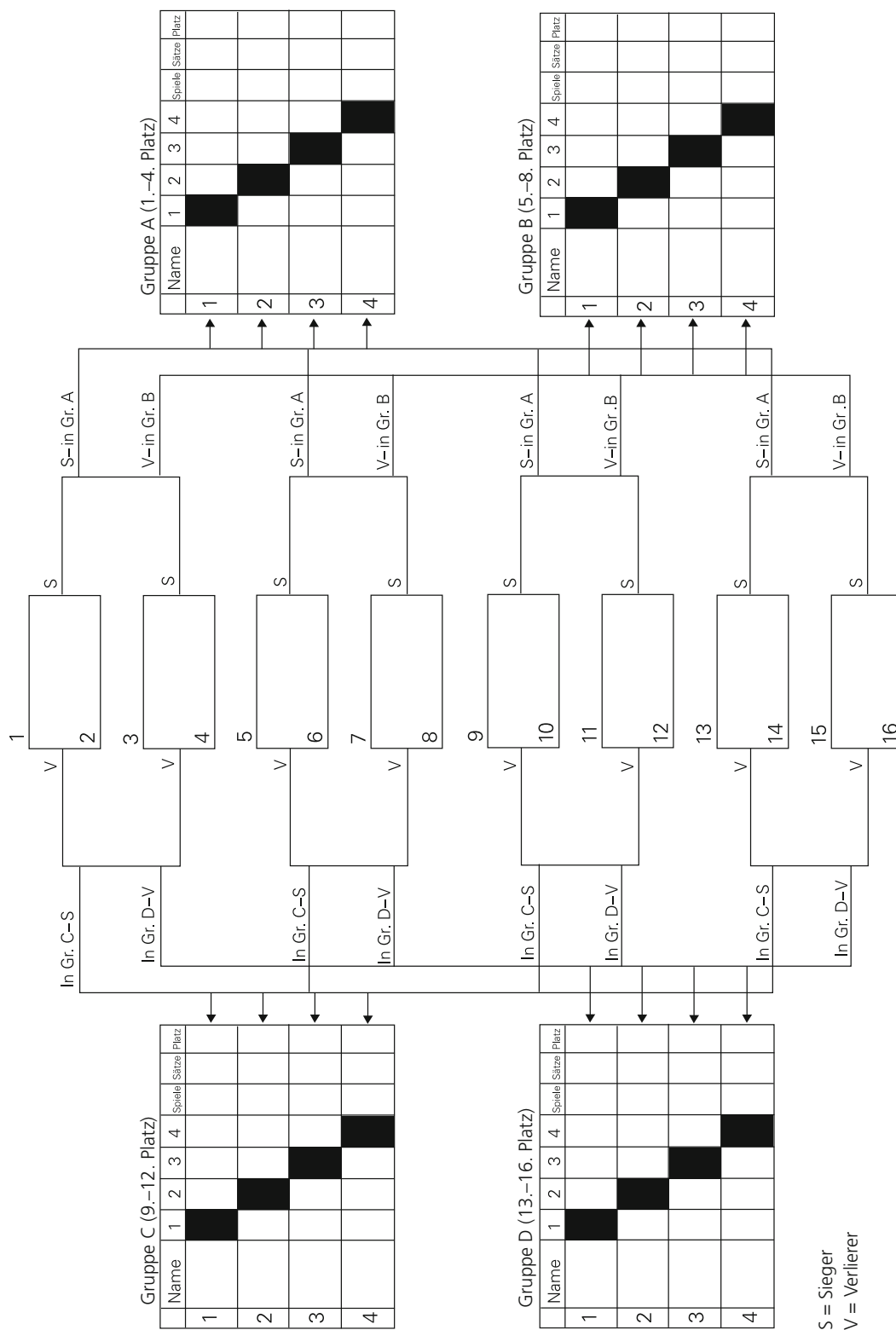



Gruppen-K.O.-Turnier

Gruppe B

	Name	1	2	3	4	5	Spiele	Sätze	Platz
1		■							
2			■						
3				■					
4					■				
5						■			

Gruppe A

	Name	1	2	3	4	Spiele	Sätze	Platz
1		■						
2			■					
3				■				
4					■			

A1 = 1. von Gruppe A
 B2 = 2. von Gruppe B
 S = Sieger
 V = Verlierer

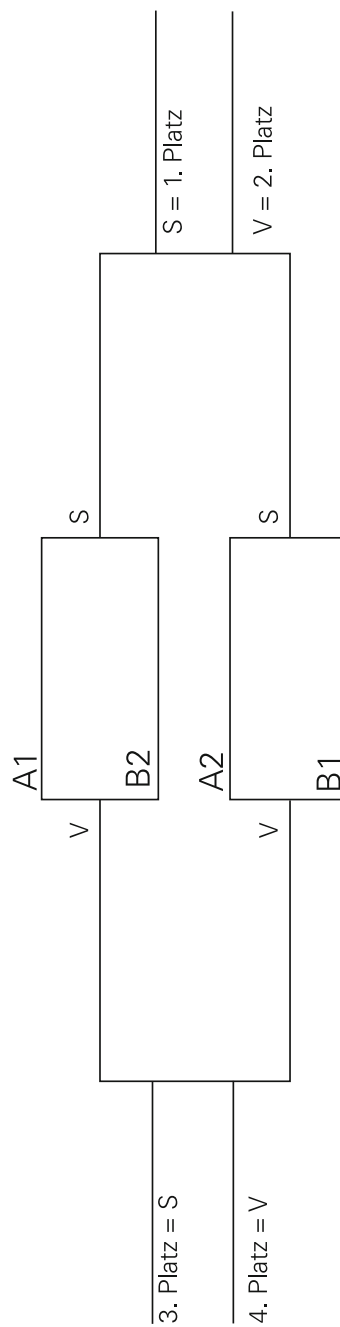



Gruppen-K.O.-Turnier

Gruppe A

	Name	1	2	3	4	Spiele	Sätze	Platz
1		■						
2			■					
3				■				
4					■			

Gruppe B

	Name	1	2	3	4	Spiele	Sätze	Platz
1		■						
2			■					
3				■				
4					■			

Gruppe C

	Name	1	2	3	4	Spiele	Sätze	Platz
1		■						
2			■					
3				■				
4					■			

Gruppe D

	Name	1	2	3	4	Spiele	Sätze	Platz
1		■						
2			■					
3				■				
4					■			

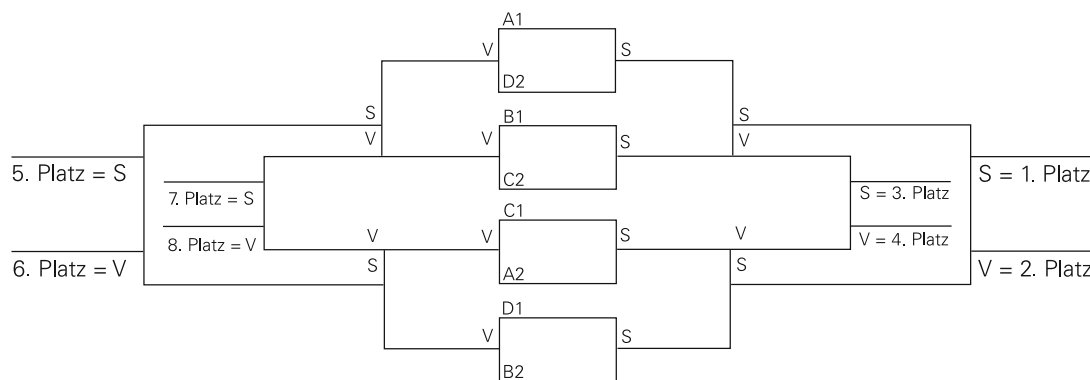

A1 = 1. von Gruppe A

B2 = 2. von Gruppe B

S = Sieger

V = Verlierer

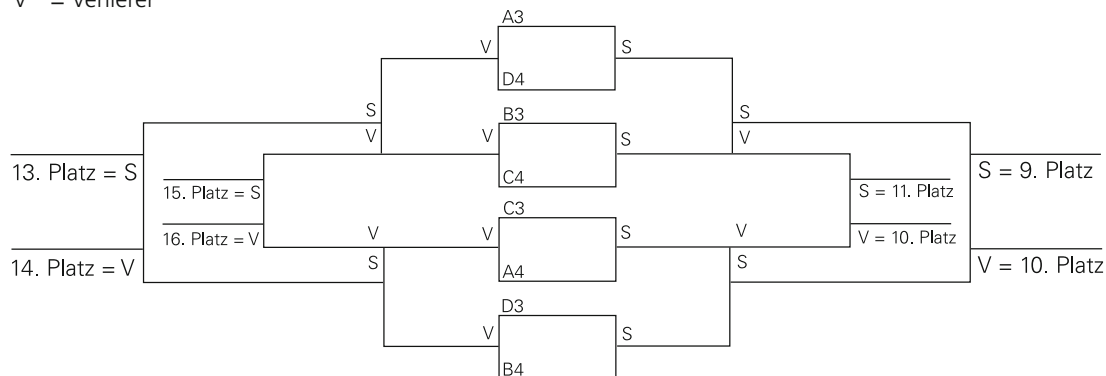



Kästliturnier

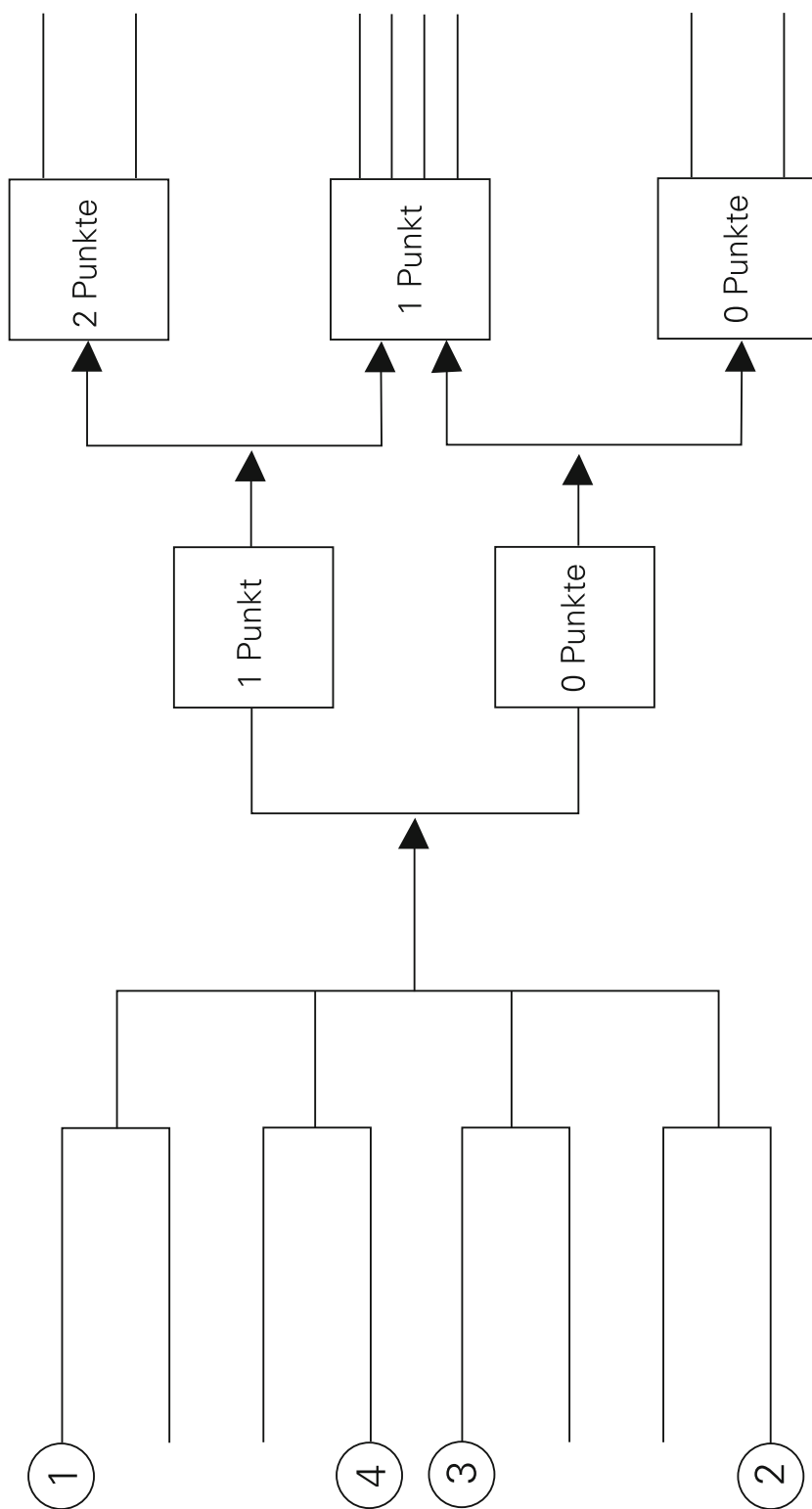

○ gesetzte Spieler Nr. 1–4



Kästliturnier

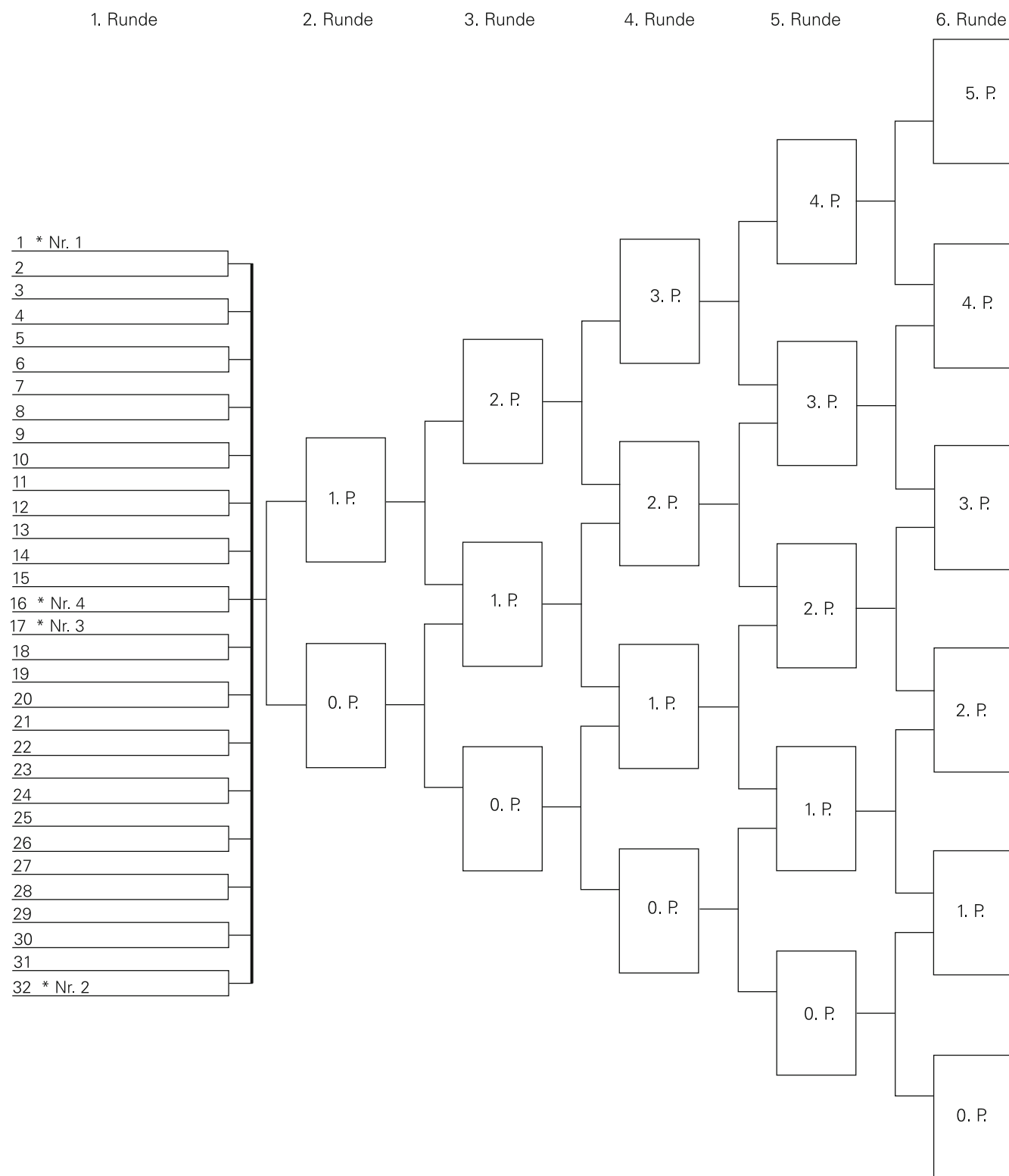

Jeder gegen jeden

Spielplan		4/2			
A	B	1	2	3	4
1-2	3-4				
4-3	2-1				
4-2	3-1				
1-3	2-4				
2-3	1-4				
4-1	3-2				
Total					

Spielplan für 4 Mannschaften (1-4) mit 2 Spielfeldern (A-B)



Jeder gegen jeden

Spielplan		5/2				
A	B	1	2	3	4	5
4-2	3-1					
3-2	5-4					
1-4	2-5					
5-3	2-1					
1-5	4-3					
Total						

Spielplan für 5 Mannschaften (1-5) mit 2 Spielfeldern (A-B)



Jeder gegen jeden

Spielplan		6/2					
A	B	1	2	3	4	5	6
2-4	1-3						
3-5	4-6						
1-4	5-2						
6-3	2-1						
3-2	4-5						
5-6	4-3						
5-1	2-6						
6-1							
Total							

Spielplan für 6 Mannschaften (1-6) mit 2 Spielfeldern (A-B)



Jeder gegen jeden

Spielplan		6/3						
A	B	C	1	2	3	4	5	6
3-1	2-4	6-5						
4-6	5-3	1-2						
3-2	6-1	5-4						
5-2	1-4	3-6						
1-5	2-6	4-3						
Total								

Spielplan für 6 Mannschaften (1-6) mit 3 Spielfeldern (A-C)



Jeder gegen jeden

Spielplan		7/3										
		A	B	C	1	2	3	4	5	6	7	
1-6	2-5	3-4										
7-5	1-4	2-3										
6-4	7-3	1-2										
5-3	6-2	7-1										
4-2	5-1	6-7										
3-1	4-7	5-6										
2-7	3-6	4-5										
Total												

Spielplan für 7 Mannschaften (1-7) mit 3 Spielfeldern (A-C)



Jeder gegen jeden

Spielplan		8/3								
A	B	C	1	2	3	4	5	6	7	8
1-8	2-6	3-5								
5-1	4-2									
7-6	4-8	1-3								
6-5	3-7	8-2								
2-3	5-4	7-1								
5-8	3-6	1-4								
4-7	2-5	8-6								
1-2	8-3	7-5								
4-3	6-1	7-2								
8-7	4-6									
Total										

Spielplan für 8 Mannschaften (1-8) mit 3 Spielfeldern (A-C)



Jeder gegen jeden

Spielplan		8/4											
		A	B	C	D	1	2	3	4	5	6	7	8
1-8	2-7	3-6	5-4										
7-8	6-1	5-2	4-3										
3-2	8-5	1-4	6-7										
5-6	7-4	8-3	2-1										
3-7	2-6	8-4	1-5										
4-2	5-3	7-1	6-8										
4-6	1-3	7-5	2-8										
Total													

Spielplan für 8 Mannschaften (1-8) mit 4 Spielfeldern (A-D)



Jeder gegen jeden

Spielplan										9/4		
A	B	C	D	1	2	3	4	5	6	7	8	9
1-8	2-7	3-6	4-5									
9-7	1-6	2-5	3-4									
8-6	9-5	1-4	2-3									
7-5	8-4	9-3	1-2									
6-4	7-3	8-2	9-1									
5-3	6-2	7-1	8-9									
4-2	5-1	6-9	7-8									
3-1	4-9	5-8	6-7									
2-9	3-8	4-7	5-6									
Total												

Spielplan für 9 Mannschaften (1-9) mit 4 Spielfeldern (A-D)



Jeder gegen jeden

Spielplan										10/5				
A	B	C	D	E	1	2	3	4	5	6	7	8	9	10
	6: 3x		7: 3x	10: 3x										
10-1	7-4	6-5	9-2	8-3										
7-2	6-3	5-4	8-1	10-9										
4-3	5-2	10-8	7-9	6-1										
9-4	8-5	7-6	1-3	10-2										
3-9	10-6	2-1	5-7	4-8										
10-5	2-8	1-9	4-6	3-7										
2-6	1-7	9-8	3-5	10-4										
8-7	9-6	10-3	2-4	1-5										
6-8	4-1	3-2	10-7	5-9										
Total														

Spielplan für 10 Mannschaften (1-10) mit 5 Spielfeldern (A-E)





Jeder gegen jeden

Spielplan											11/5				
A	B	C	D	E	1	2	3	4	5	6	7	8	9	10	11
1-10	2-9	3-8	4-7	5-6											
11-9	1-8	2-7	3-6	4-5											
10-8	11-7	1-6	2-5	3-4											
9-7	10-6	11-5	1-4	2-3											
8-6	9-5	10-4	11-3	1-2											
7-5	8-4	9-3	10-2	11-1											
6-4	7-3	8-2	9-1	10-11											
5-3	6-2	7-1	8-11	9-10											
1-2	5-1	6-11	7-10	8-9											
3-1	4-11	5-10	6-9	7-8											
2-11	3-10	4-9	5-8	6-7											
Total															

Spielplan für 11 Mannschaften (1-11) mit 5 Spielfeldern (A-E)

Jeder gegen jeden

		Spielplan															
		12/6															
A	B	C	D	E	F	1	2	3	4	5	6	7	8	9	10	11	12
12-1	7-6	10-3	9-4	8-5	11-2												
12-11	10-1	7-4	5-6	9-2	8-3												
9-11	12-10	8-1	7-2	6-3	5-4												
8-10	7-11	12-9	6-1	5-2	4-3												
7-9	3-2	5-11	12-8	4-1	6-10												
6-8	5-9	4-10	3-11	12-7	2-1												
5-7	4-8	3-9	2-10	1-11	12-6												
4-6	12-5	2-8	1-9	11-10	3-7												
3-5	2-6	1-7	11-8	12-4	10-9												
2-4	9-8	11-6	12-3	10-7	1-5												
1-3	11-4	12-2	10-5	9-6	8-7												
Total																	

Spielplan für 12 Mannschaften (1-12) mit 6 Spielfeldern (A-F)





Jeder gegen jeden

		Spielplan													13/6			
A	B	C	D	E	F	1	2	3	4	5	6	7	8	9	10	11	12	13
1-12	2-11	3-10	4-9	5-8	6-7													
13-11	1-10	2-9	3-8	4-7	5-6													
12-10	13-9	1-8	2-7	3-6	4-5													
11-9	12-8	13-7	1-6	2-5	3-4													
10-8	11-7	12-6	13-5	1-4	2-3													
9-7	10-6	11-5	12-4	13-3	1-2													
8-6	9-5	10-4	11-3	12-2	13-1													
7-5	8-4	9-3	10-2	11-1	12-13													
6-4	7-3	8-2	9-1	10-13	11-12													
5-3	6-2	7-1	8-13	9-12	10-11													
4-2	5-1	6-13	7-12	8-11	9-10													
3-1	4-13	5-12	6-11	7-10	8-9													
2-13	3-12	4-11	5-10	6-9	7-8													
Total																		

Spielplan für 13 Mannschaften (1-13) mit 6 Spielfeldern (A-F)



Losturnier-Spielerblatt

gewonnenes Spiel 2 Punkte
unentschiedenes Spiel 1 Punkt
verlorenes Spiel 0 Punkte

Name:	Rang:	<input type="text"/>
-------	-------	----------------------

	Resultat	Punkte
1. Spielrunde	:	
2. Spielrunde	:	
3. Spielrunde	:	
4. Spielrunde	:	
5. Spielrunde	:	
6. Spielrunde	:	
7. Spielrunde	:	
8. Spielrunde	:	
9. Spielrunde	:	
10. Spielrunde	:	
Differenz: <input type="text"/>	Total	:



Davis-Cup-Spielerblatt

Mannschaft A	Spielername	Mannschaft B	Spielername	Resultat	Punkte
1. Einzel		1. Einzel			
2. Einzel		2. Einzel			
1. Doppel		1. Doppel			
Spielergesamt					