



Schémas de jeu

Vous trouverez dans la brochure «Formes de tournois» une description précise des schémas de jeu illustrés ci-après.

Source:

Office fédéral du sport OFSPO

Documentation J+S

2532 Macolin

Courriel: dok.js@baspo.admin.ch

Informations utiles

Après des fédérations ci-dessous.

swiss badminton

www.badminton.ch

SWISS SQUASH

www.squash.ch

Swiss Tennis

www.myTennis.ch

Fédération Suisse de Tennis de Table

www.sttv.ch





Tournoi par K.-O.

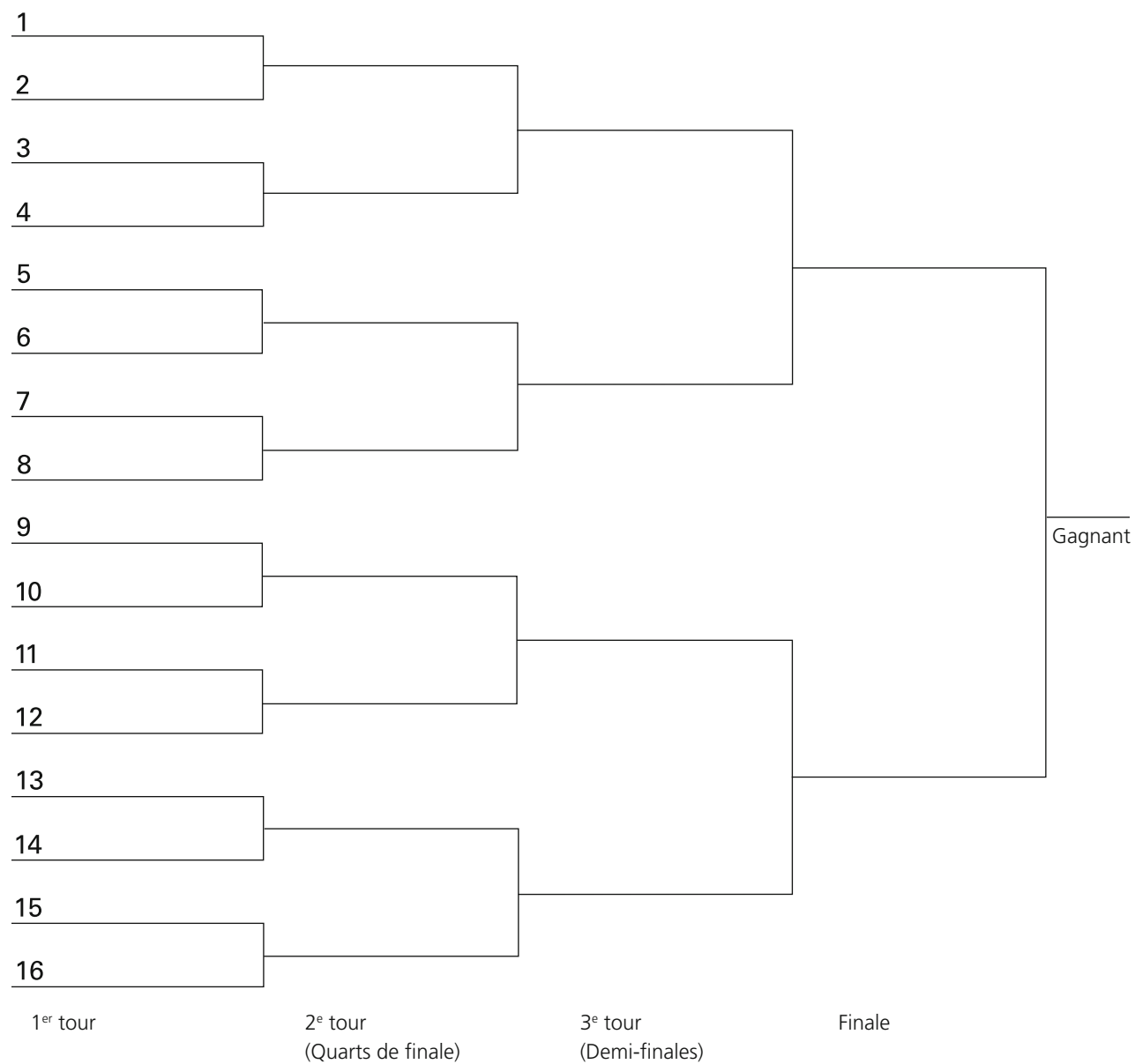



Tournoi par K.-O.

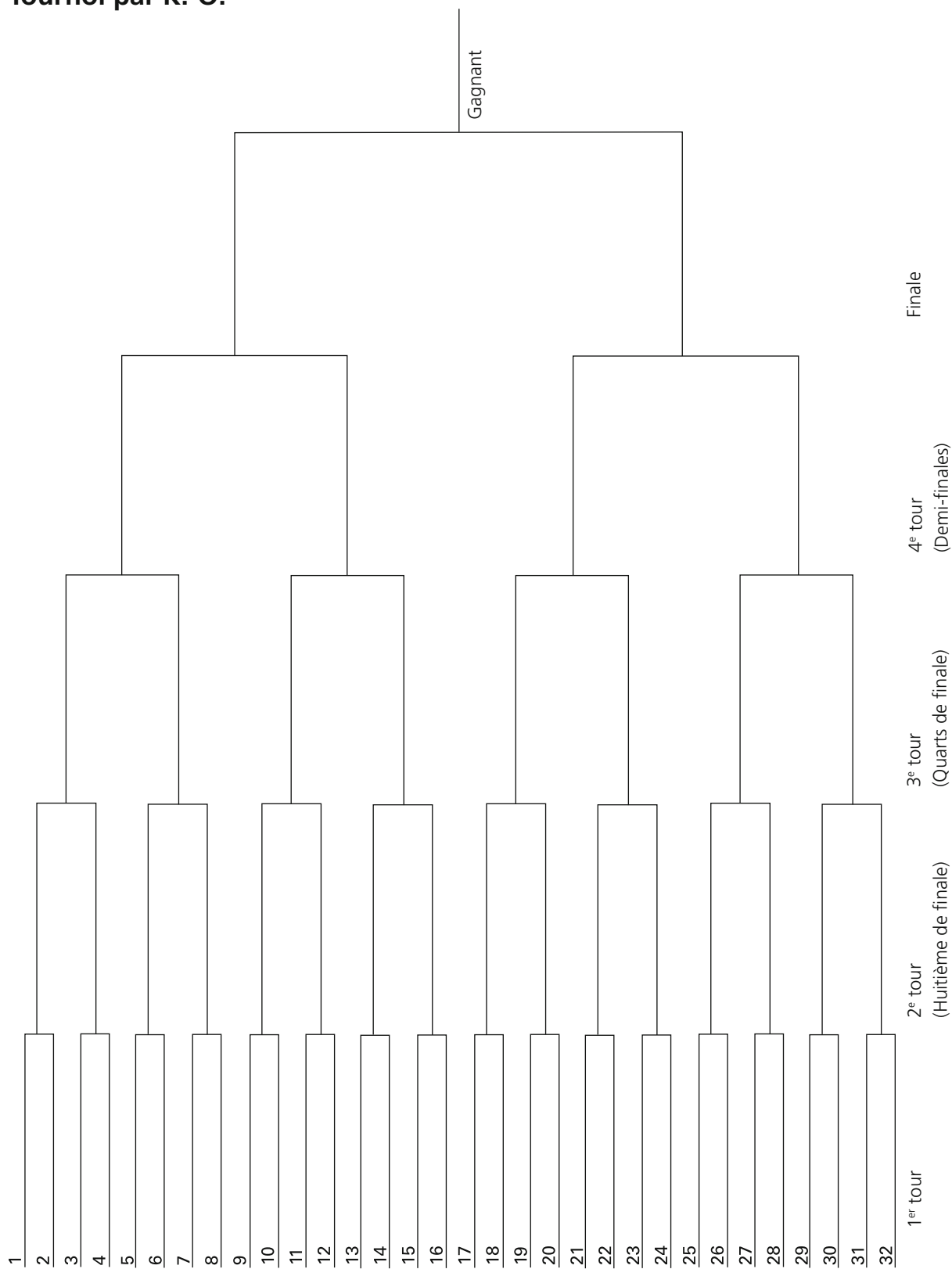



Tournoi par double K.-O.

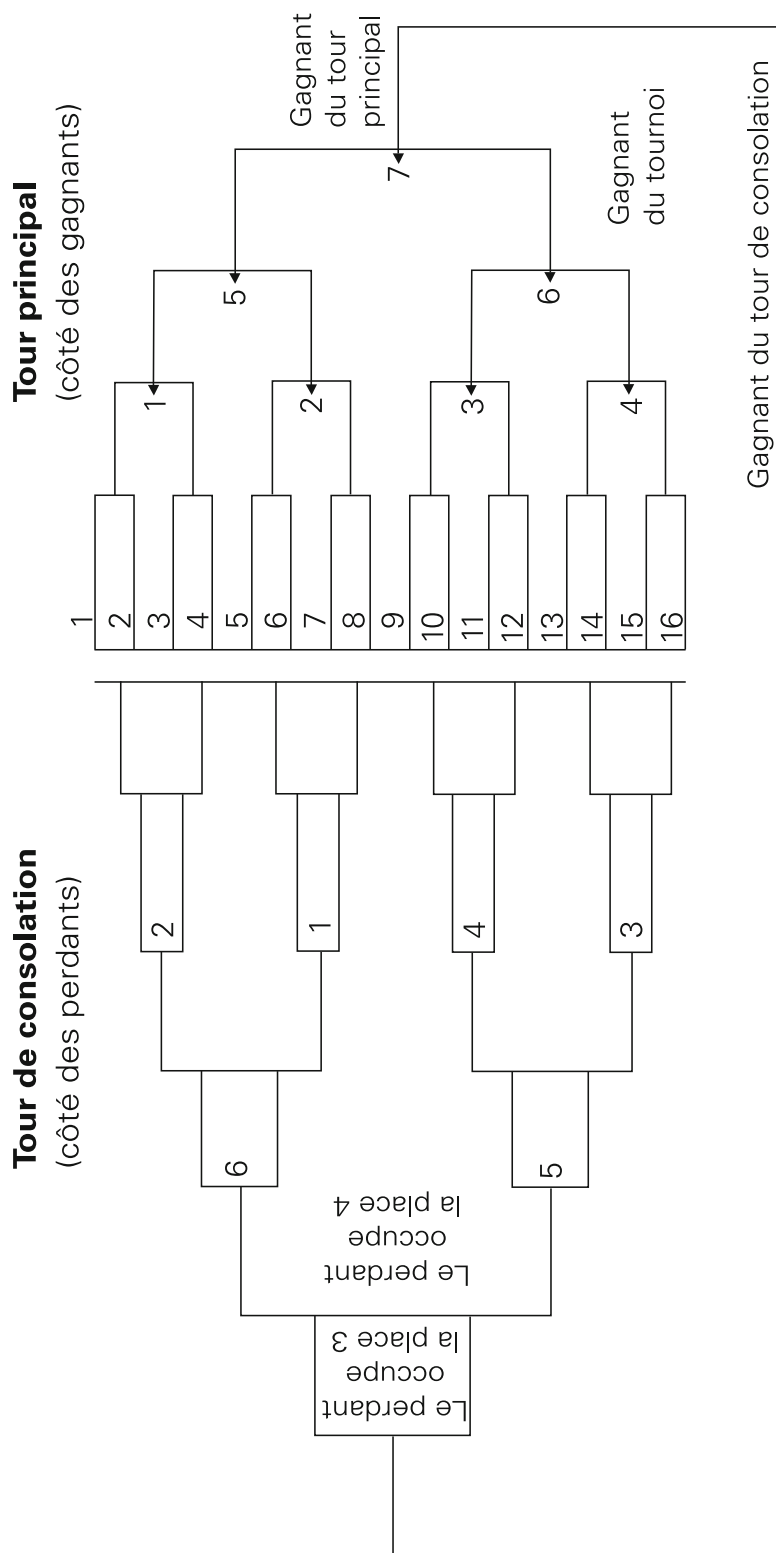



Tournoi par double K.-O.

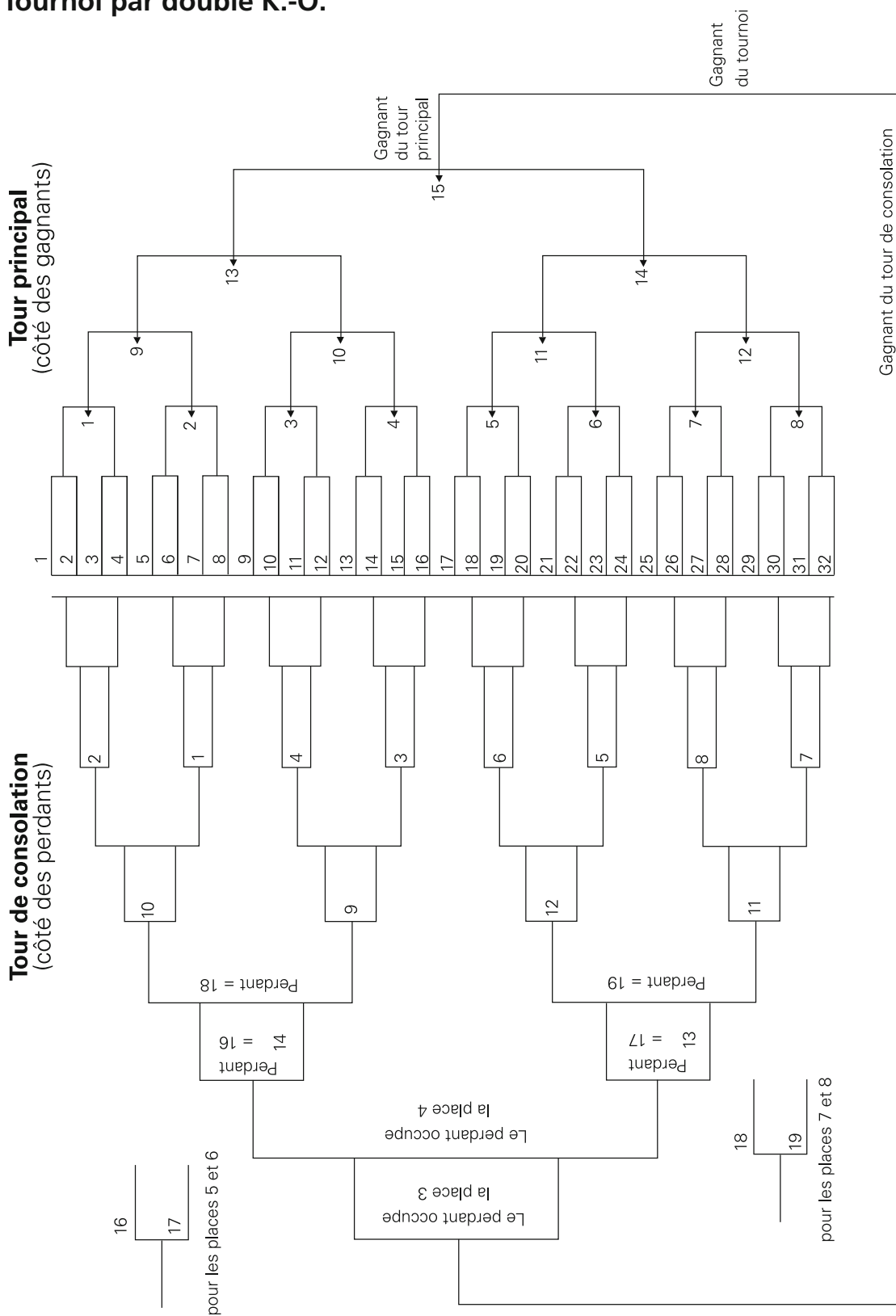



Tournoi de classement

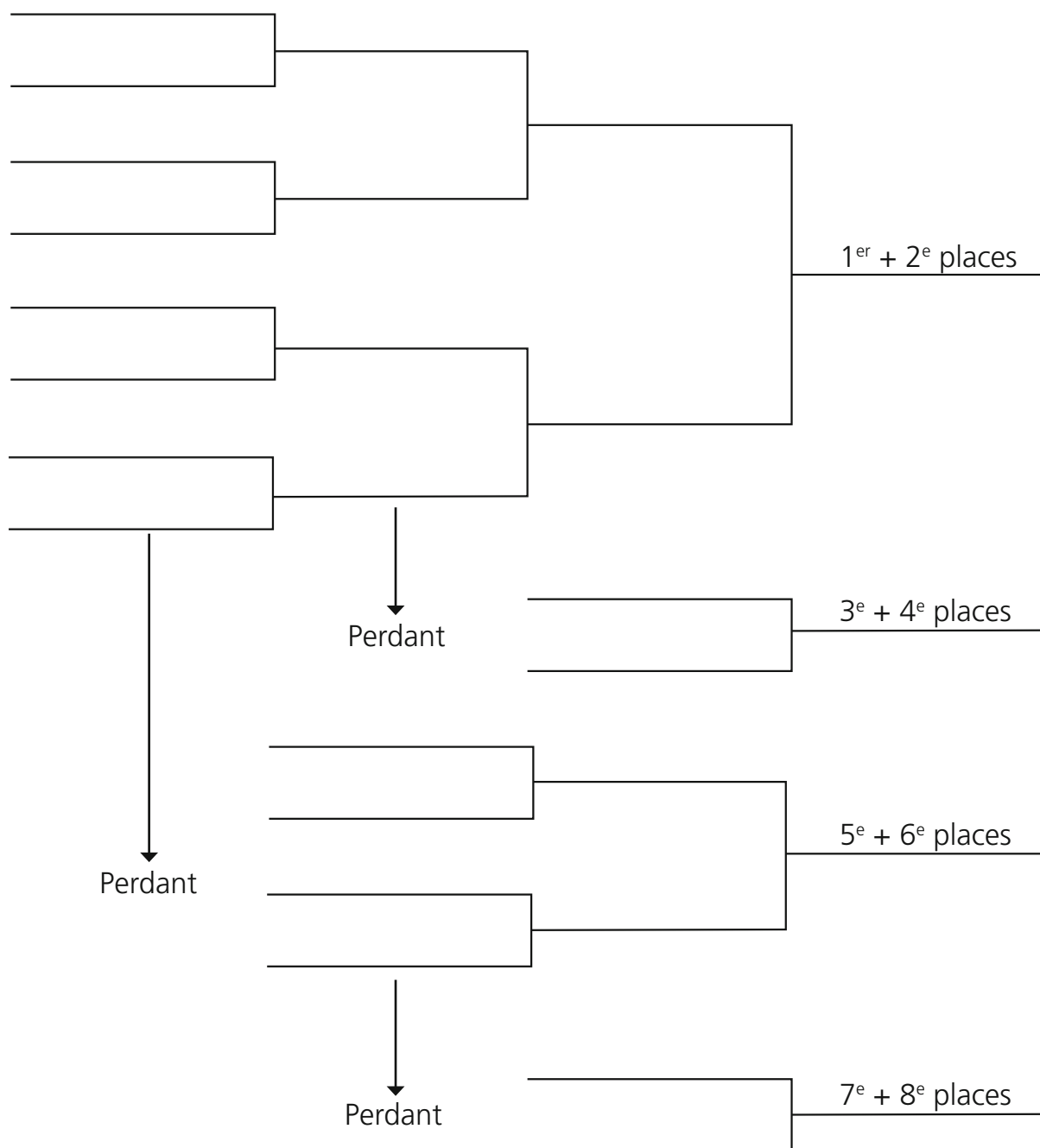



Tournoi de classement

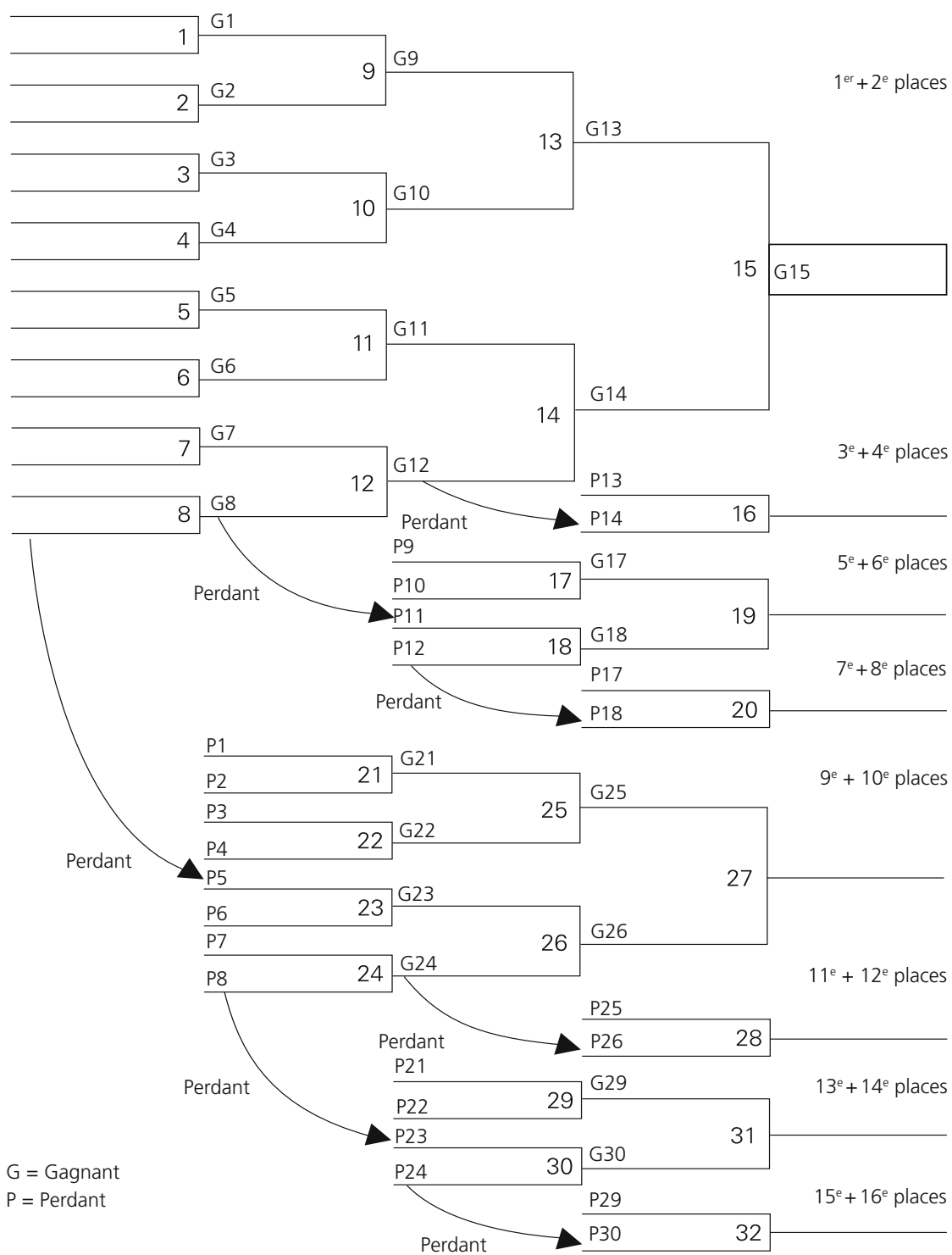



Tournoi de classement

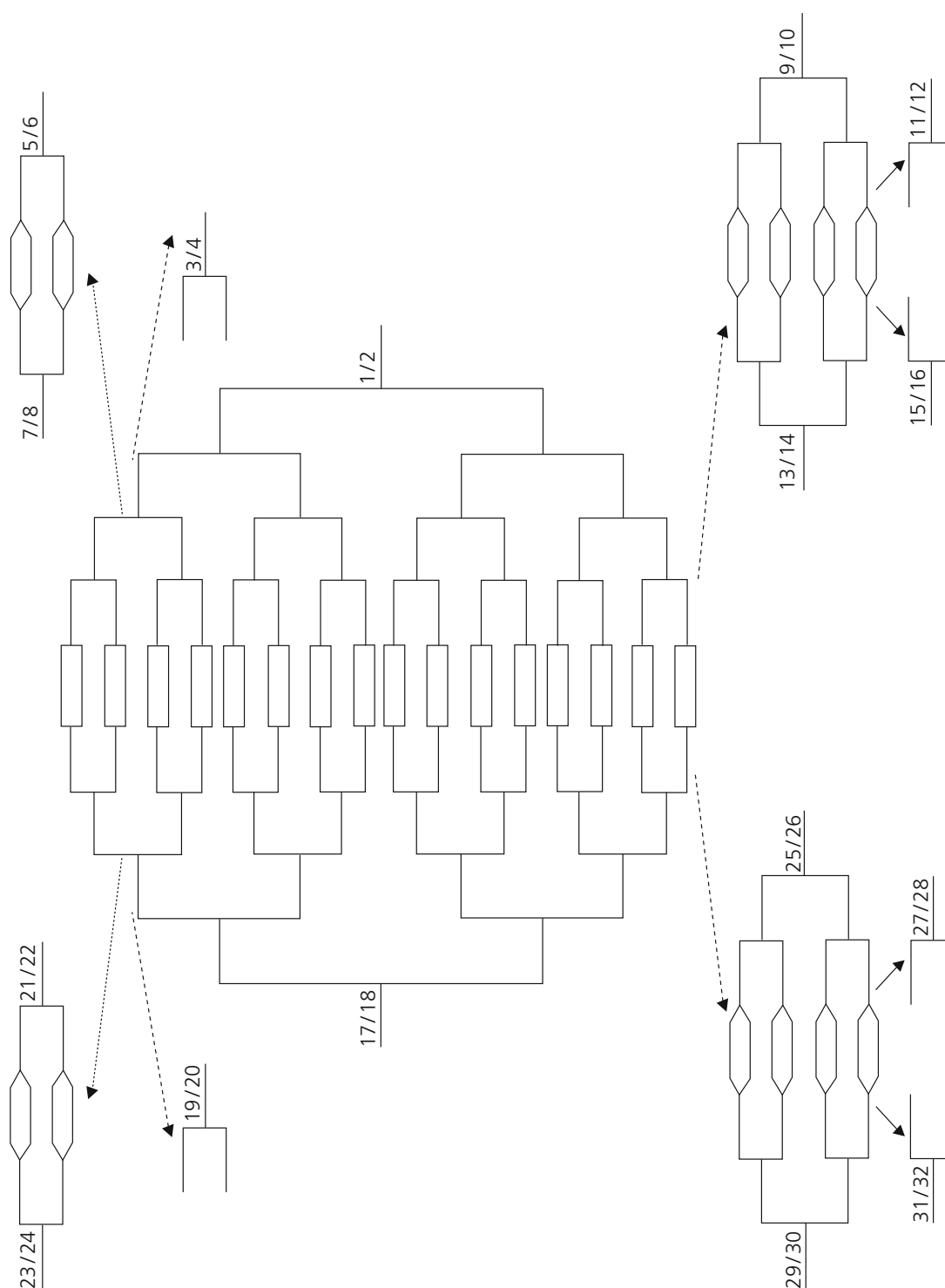



Tournoi combiné par K.-O. et groupes

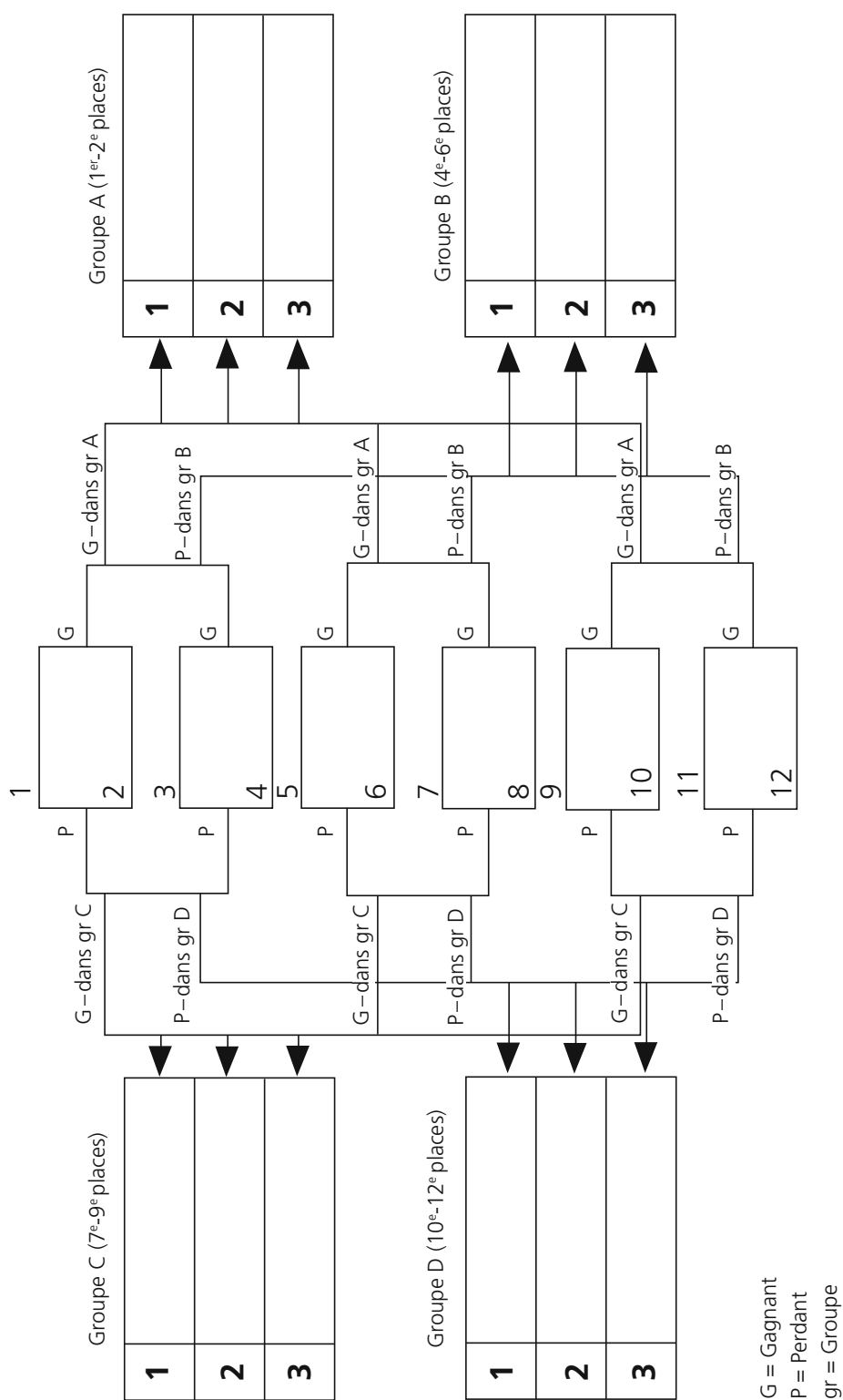



Tournoi combiné par K.-O.

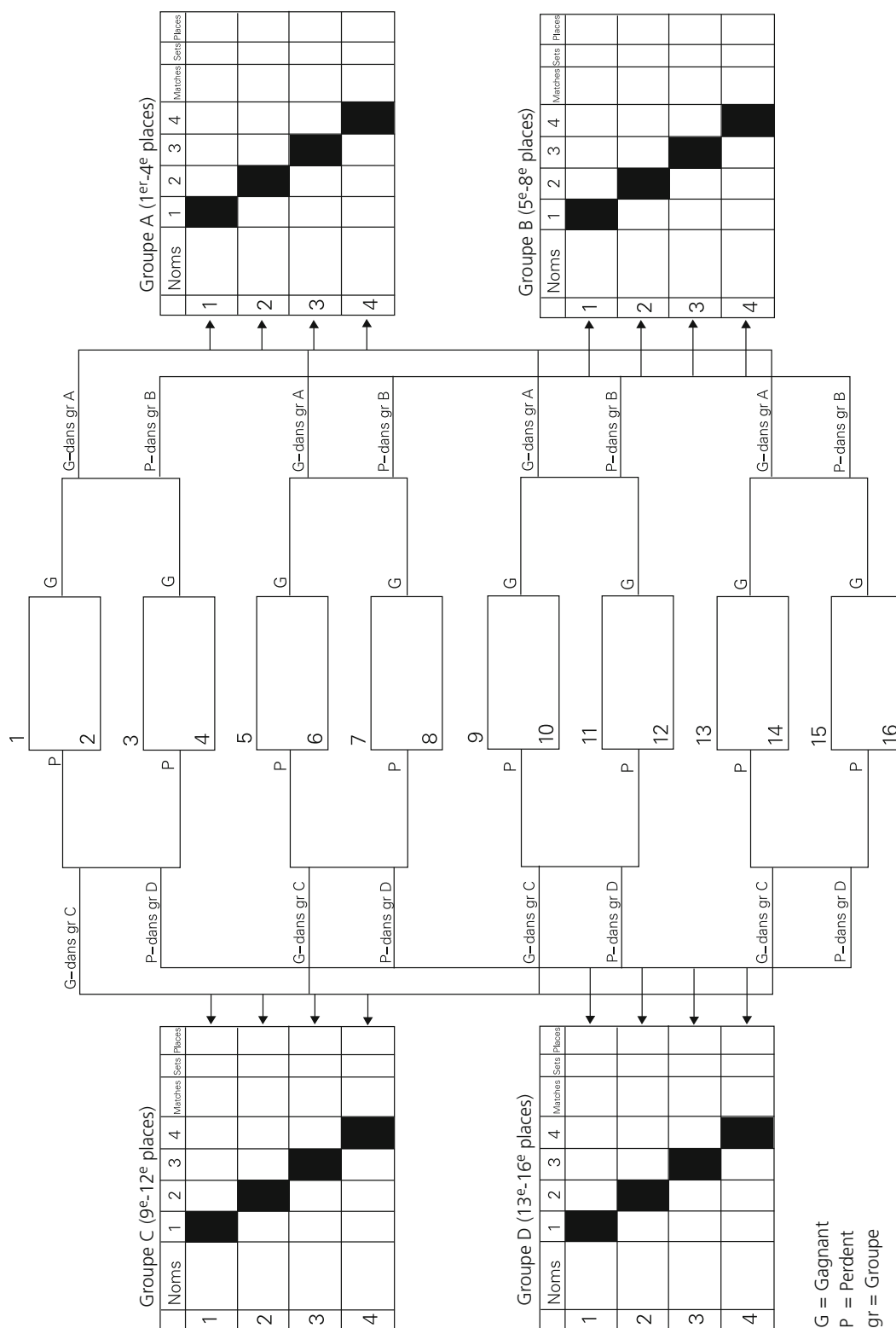



Tournoi combiné par groupes et K.-O.

Groupe B

	Noms	1	2	3	4	5	Matches	Sets	Places
1		■							
2			■						
3				■					
4					■				
5						■			

Groupe A

	Noms	1	2	3	4	Matches	Sets	Places
1		■						
2			■					
3				■				
4					■			

A1 = 1^{er} du groupe A
 B2 = 2^e du groupe B
 G = Gagnant
 P = Perdant

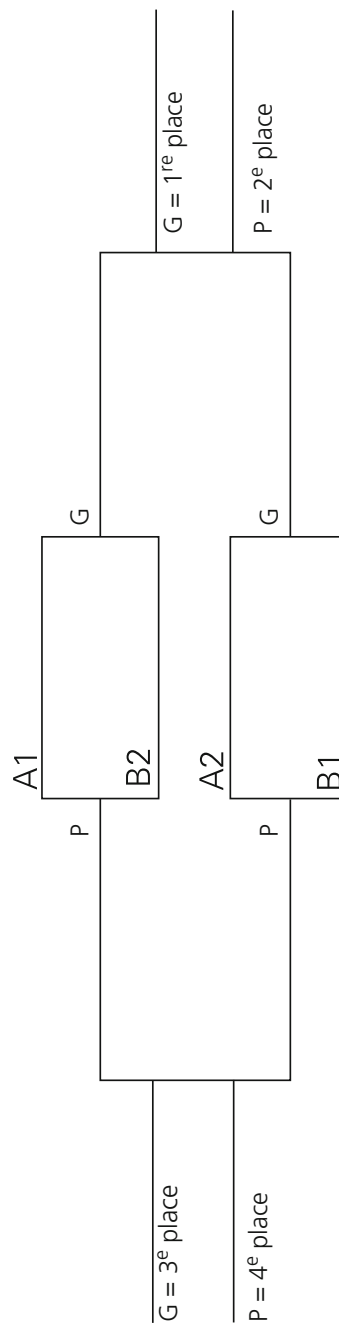



Tournoi combiné par groupes et K.-O.

Groupe A

	Noms	1	2	3	4	Matches	Sets	Places
1		■						
2			■					
3				■				
4					■			

Groupe B

	Noms	1	2	3	4	Matches	Sets	Places
1		■						
2			■					
3				■				
4					■			

Groupe C

	Noms	1	2	3	4	Matches	Sets	Places
1		■						
2			■					
3				■				
4					■			

Groupe D

	Noms	1	2	3	4	Matches	Sets	Places
1		■						
2			■					
3				■				
4					■			

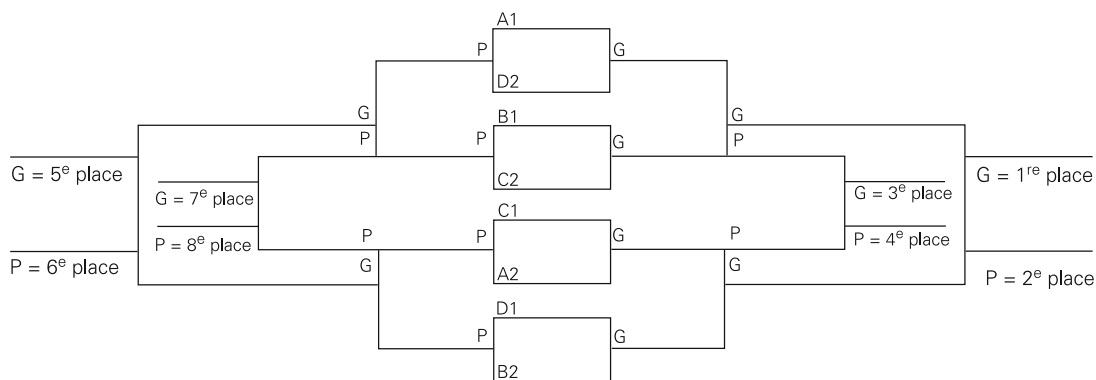

A1 = 1^{er} du groupe A

B2 = 2^e du groupe B

V = Gagnat

P = perdant

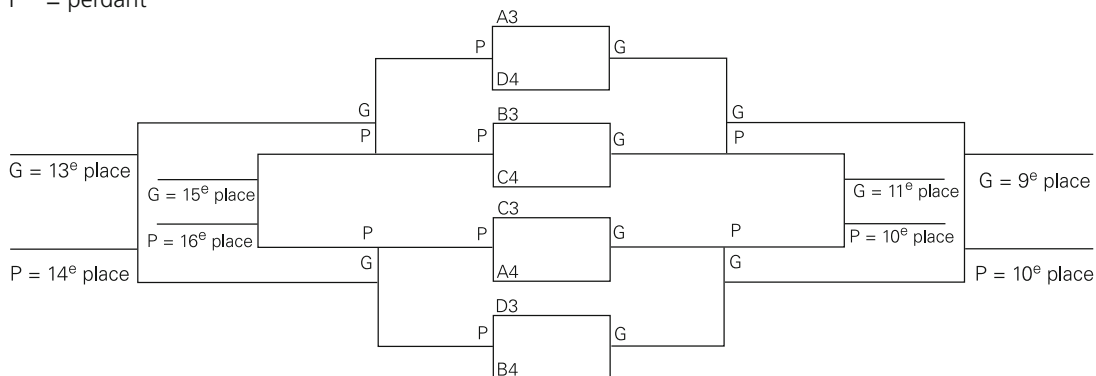



Tournoi du caisson

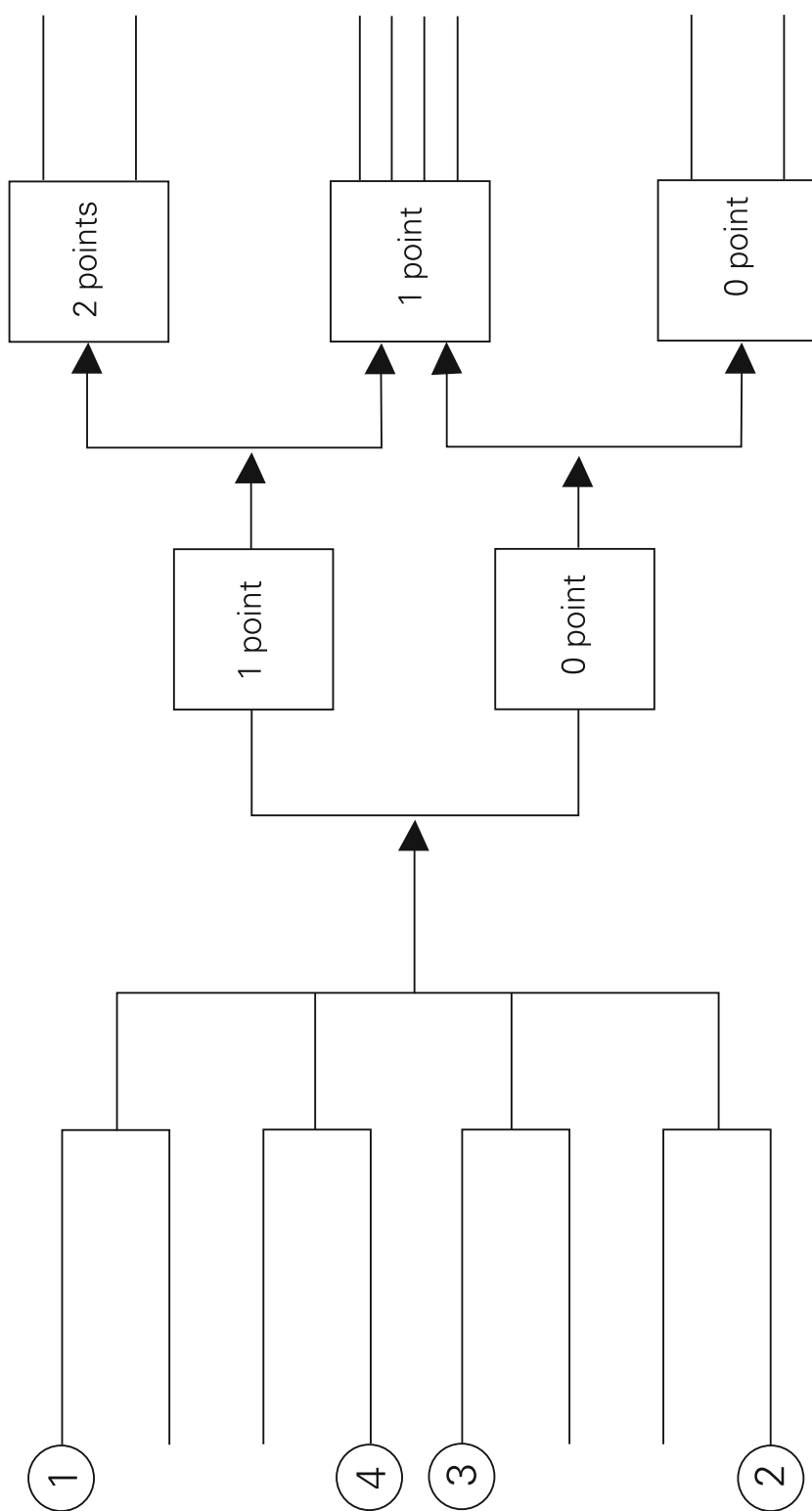

○ Joueurs n° 1-4 placés



Tournoi de caisson

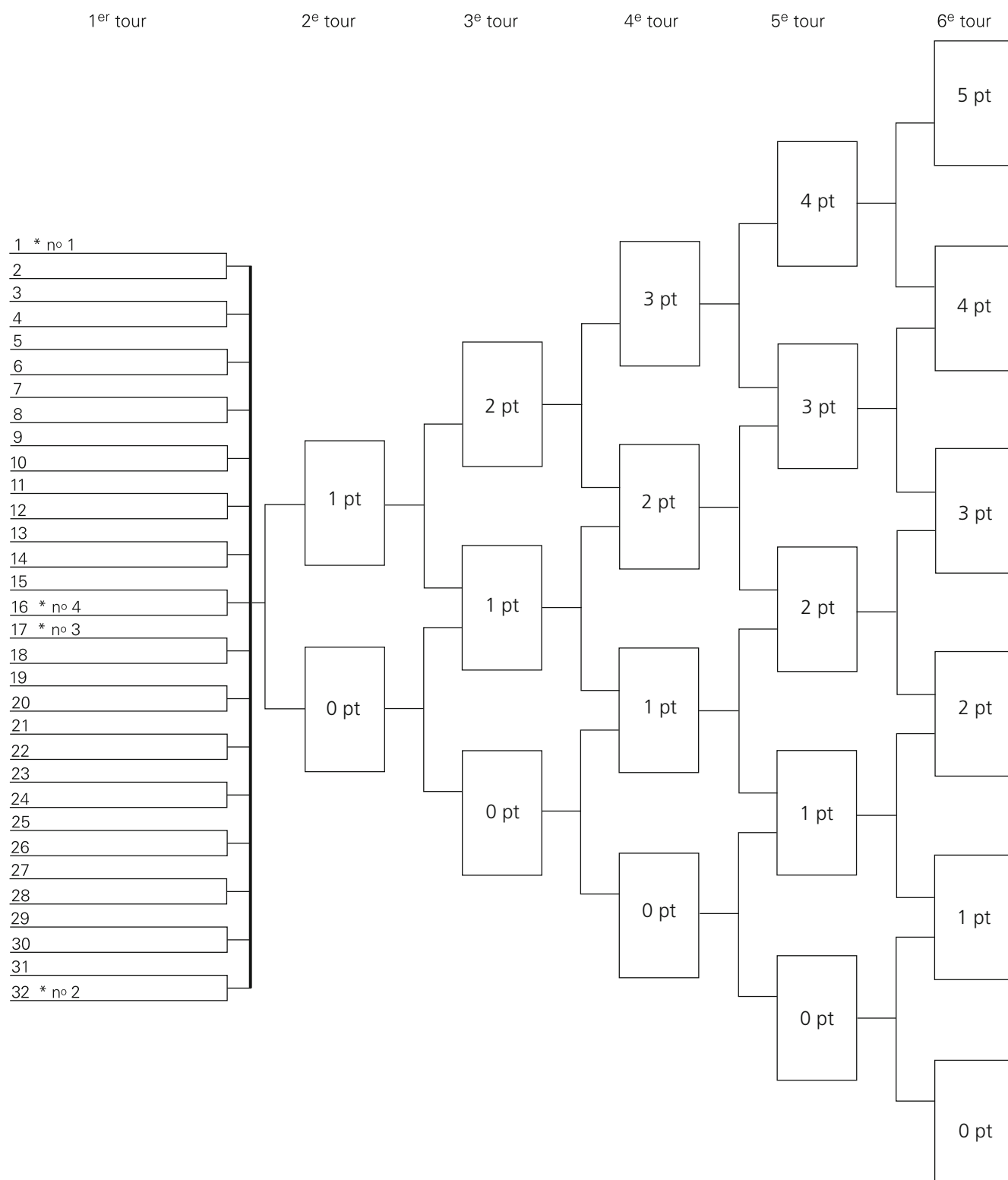

Tournoi un contre un

Schéma de jeu		4/2					
		A	B	1	2	3	4
1-2	3-4						
4-3	2-1						
4-2	3-1						
1-3	2-4						
2-3	1-4						
4-1	3-2						
Total							

Schéma de jeu pour 4 équipes (1-4) sur 2 terrains (A-B)



Tournoi un contre un

Schéma de jeu		5/2				
A	B	1	2	3	4	5
4-2	3-1					
3-2	5-4					
1-4	2-5					
5-3	2-1					
1-5	4-3					
Total						

Schéma de jeu pour 5 équipes (1-5) sur 2 terrains (A-B)



Tournoi un contre un

Schéma de jeu		6/2							
		A	B	1	2	3	4	5	6
2-4	1-3								
3-5	4-6								
1-4	5-2								
6-3	2-1								
3-2	4-5								
5-6	4-3								
5-1	2-6								
6-1									
Total									

Schéma de jeu pour 6 équipes (1-6) sur 2 terrains (A-B)



Tournoi un contre un

Schéma de jeu		6/3						
A	B	C	1	2	3	4	5	6
3-1	2-4	6-5						
4-6	5-3	1-2						
3-2	6-1	5-4						
5-2	1-4	3-6						
1-5	2-6	4-3						
Total								

Schéma de jeu pour 6 équipes (1-6) sur 3 terrains (A-C)





Tournoi un contre un

Schéma de jeu		7/3							
A	B	C	1	2	3	4	5	6	7
1-6	2-5	3-4							
7-5	1-4	2-3							
6-4	7-3	1-2							
5-3	6-2	7-1							
4-2	5-1	6-7							
3-1	4-7	5-6							
2-7	3-6	4-5							
Total									

Schéma de jeu pour 7 équipes (1-7) sur 3 terrains (A-C)

Tournoi un contre un

Schéma de jeu									8/3	
A	B	C	1	2	3	4	5	6	7	8
1-8	2-6	3-5								
	5-1	4-2								
7-6	4-8	1-3								
6-5	3-7	8-2								
2-3	5-4	7-1								
5-8	3-6	1-4								
4-7	2-5	8-6								
1-2	8-3	7-5								
4-3	6-1	7-2								
	8-7	4-6								
Total										

Schéma de jeu pour 8 équipes (1-8) sur 3 terrains (A-C)



Tournoi un contre un

Schéma de jeu										8/4	
A	B	C	D	1	2	3	4	5	6	7	8
1-8	2-7	3-6	5-4								
7-8	6-1	5-2	4-3								
3-2	8-5	1-4	6-7								
5-6	7-4	8-3	2-1								
3-7	2-6	8-4	1-5								
4-2	5-3	7-1	6-8								
4-6	1-3	7-5	2-8								
Total											

Schéma de jeu pour 8 équipes (1-8) sur 4 terrains (A-D)



Tournoi un contre un

Schéma de jeu										9/4		
A	B	C	D	1	2	3	4	5	6	7	8	9
1-8	2-7	3-6	4-5									
9-7	1-6	2-5	3-4									
8-6	9-5	1-4	2-3									
7-5	8-4	9-3	1-2									
6-4	7-3	8-2	9-1									
5-3	6-2	7-1	8-9									
4-2	5-1	6-9	7-8									
3-1	4-9	5-8	6-7									
2-9	3-8	4-7	5-6									
Total												

Schéma de jeu pour 9 équipes (1-9) sur 4 terrains (A-D)



Tournoi un contre un

Schéma de jeu										10/5				
A	B	C	D	E	1	2	3	4	5	6	7	8	9	10
	6 : 3 x		7 : 3 x	10 : 3 x										
10-1	7-4	6-5	9-2	8-3										
7-2	6-3	5-4	8-1	10-9										
4-3	5-2	10-8	7-9	6-1										
9-4	8-5	7-6	1-3	10-2										
3-9	10-6	2-1	5-7	4-8										
10-5	2-8	1-9	4-6	3-7										
2-6	1-7	9-8	3-5	10-4										
8-7	9-6	10-3	2-4	1-5										
6-8	4-1	3-2	10-7	5-9										
Total														

Schéma de jeu pour 10 équipes (1-10) sur 5 terrains (A-E)





Tournoi un contre un

Schéma de jeu											11/5				
A	B	C	D	E	1	2	3	4	5	6	7	8	9	10	11
1-10	2-9	3-8	4-7	5-6											
11-9	1-8	2-7	3-6	4-5											
10-8	11-7	1-6	2-5	3-4											
9-7	10-6	11-5	1-4	2-3											
8-6	9-5	10-4	11-3	1-2											
7-5	8-4	9-3	10-2	11-1											
6-4	7-3	8-2	9-1	10-11											
5-3	6-2	7-1	8-11	9-10											
1-2	5-1	6-11	7-10	8-9											
3-1	4-11	5-10	6-9	7-8											
2-11	3-10	4-9	5-8	6-7											
Total															

Schéma de jeu pour 11 équipes (1-11) sur 5 terrains (A-E)



Tournoi un contre un

	Schéma de jeu																	
	A	B	C	D	E	F							12/6					
							1	2	3	4	5	6	7	8	9	10	11	12
12-1	7-6	10-3	9-4	8-5	11-2													
12-11	10-1	7-4	5-6	9-2	8-3													
9-11	12-10	8-1	7-2	6-3	5-4													
8-10	7-11	12-9	6-1	5-2	4-3													
7-9	3-2	5-11	12-8	4-1	6-10													
6-8	5-9	4-10	3-11	12-7	2-1													
5-7	4-8	3-9	2-10	1-11	12-6													
4-6	12-5	2-8	1-9	11-10	3-7													
3-5	2-6	1-7	11-8	12-4	10-9													
2-4	9-8	11-6	12-3	10-7	1-5													
1-3	11-4	12-2	10-5	9-6	8-7													
Total																		

Schéma de jeu pour 12 équipes (1-12) sur 6 terrains (A-F)



Tournoi un contre un

		Schéma de jeu																	
		13/6																	
A	B	C	D	E	F	1	2	3	4	5	6	7	8	9	10	11	12	13	
1-12	2-11	3-10	4-9	5-8	6-7														
13-11	1-10	2-9	3-8	4-7	5-6														
12-10	13-9	1-8	2-7	3-6	4-5														
11-9	12-8	13-7	1-6	2-5	3-4														
10-8	11-7	12-6	13-5	1-4	2-3														
9-7	10-6	11-5	12-4	13-3	1-2														
8-6	9-5	10-4	11-3	12-2	13-1														
7-5	8-4	9-3	10-2	11-1	12-13														
6-4	7-3	8-2	9-1	10-13	11-12														
5-3	6-2	7-1	8-13	9-12	10-11														
4-2	5-1	6-13	7-12	8-11	9-10														
3-1	4-13	5-12	6-11	7-10	8-9														
2-13	3-12	4-11	5-10	6-9	7-8														
Total																			

Schéma de jeu pour 13 équipes (1-13) sur 6 terrains (A-F)



Tournoi par tirage au sort

Match gagné 2 points
Match nul 1 point
Match perdu 0 point

Nom:	Place:	<input type="text"/>
------	--------	----------------------

	Résultat	Points
1 ^{er} tour	:	
2 ^e tour	:	
3 ^e tour	:	
4 ^e tour	:	
5 ^e tour	:	
6 ^e tour	:	
7 ^e tour	:	
8 ^e tour	:	
9 ^e tour	:	
10 ^e tour	:	
Différence: <input type="text"/>	Total	:



Tournoi Coupe Davis

Equipe A	Nom des joueurs	Equipe B	Nom des joueurs	Résultat	Point
1 ^{er} simple		1 ^{er} simple			
2 ^e simple		2 ^e simple			
1 ^{er} double		1 ^{er} double			
Résultat du match					